

Technical Description FIBROTOR® EM. and EM.NC.



4. Drive arrangements with bevel gear

Code number Field 4

FIBROTOR EM.10, EM.12, EM.13, EM.19, EM.20, EM.NC.10, EM.NC.19, EM.NC.20

A number of drive arrangements for optimum integration of the indexing table in the machine can be achieved. The position of the terminal box can be determined for the positions 1–4 in the side view.

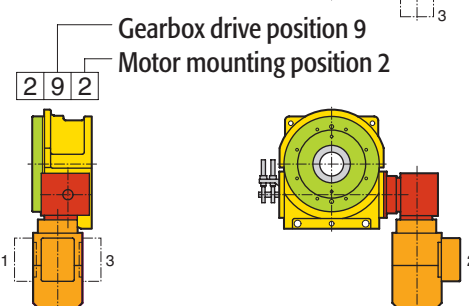
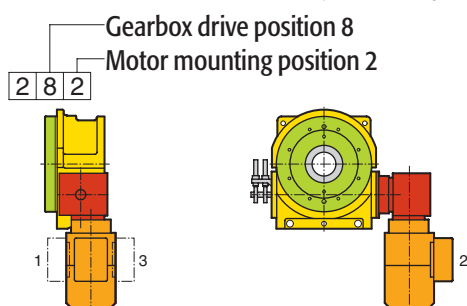
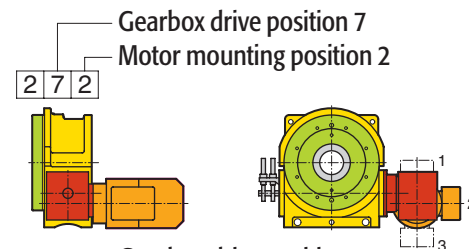
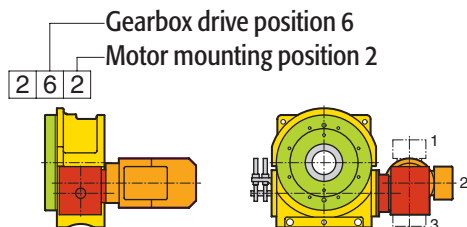
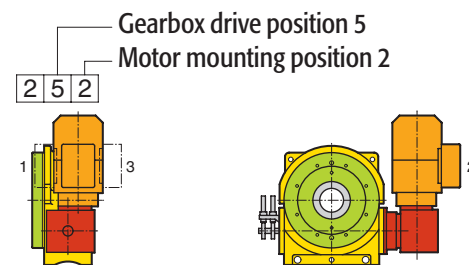
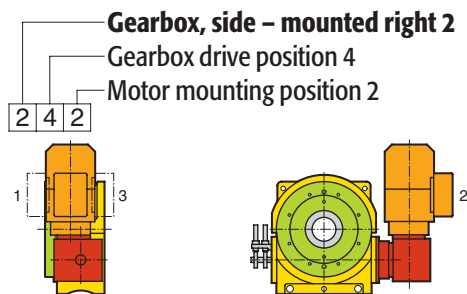
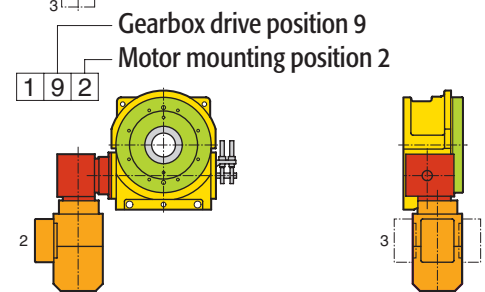
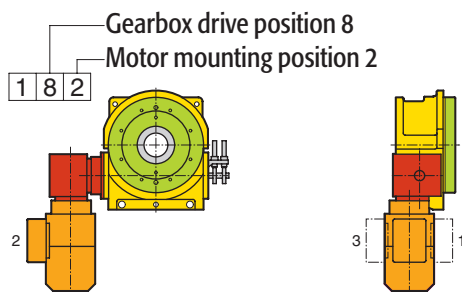
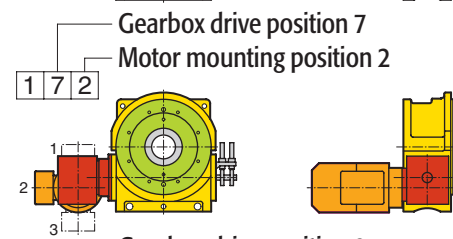
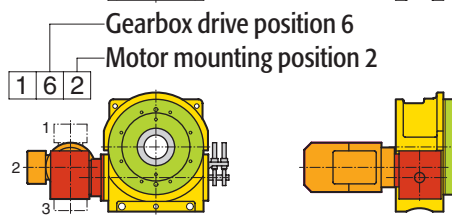
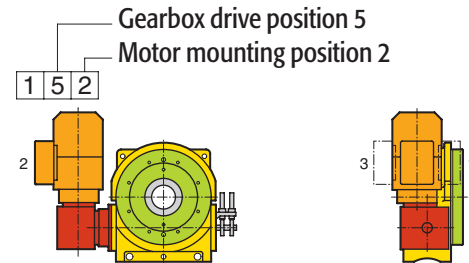
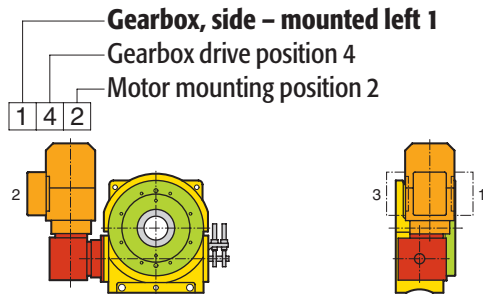



Technical Description FIBROTOR® EM. and EM.NC.

4. Drive arrangements with parallel shaft gear unit

Code number Field 4

FIBROTOR EM.01, EM.13, EM.15, EM.16, EM.17, EM.18, EM.NC.01, EM.NC.12, EM.NC.13, EM.NC.15, EM.NC.16, EM.NC.17, EM.NC.18

A number of drive arrangements for optimum integration of the indexing table in the machine can be achieved. The position of the terminal box can be determined for the positions 1-4 in the side view.

Gearbox, side – mounted left 1
Gearbox drive position 1
Motor mounting position 1

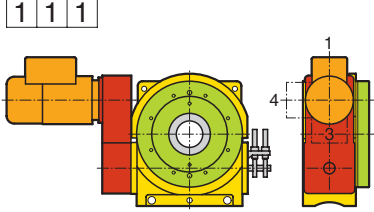

Gearbox drive position 2
Motor mounting position 1

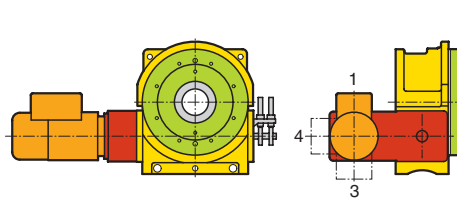

Gearbox drive position 3
Motor mounting position 1

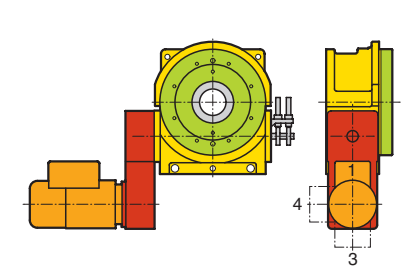

without gearbox
without motor

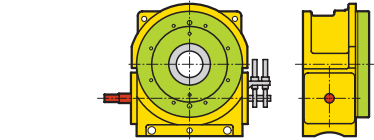

Gearbox drive position 2
Motor mounting position 2

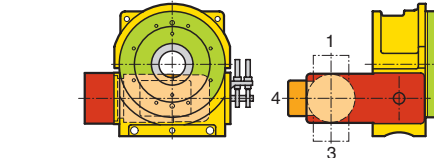

Gearbox drive position 3
Motor mounting position 2

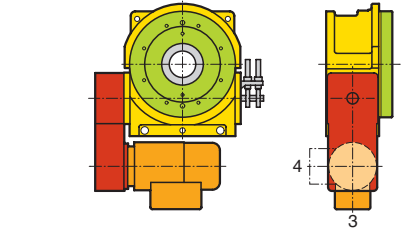

Gearbox, side – mounted right 2

Gearbox drive position 1
Motor mounting position 1

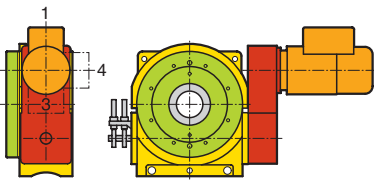

Gearbox drive position 2
Motor mounting position 1

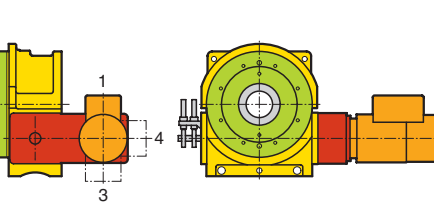

Gearbox drive position 3
Motor mounting position 1

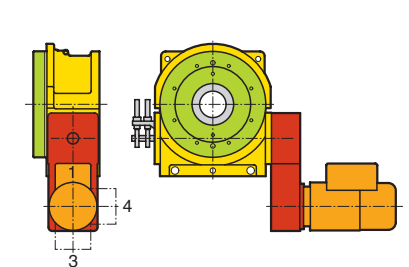

without gearbox
without motor

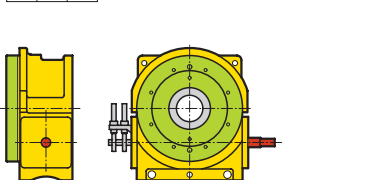

Gearbox drive position 2
Motor mounting position 2

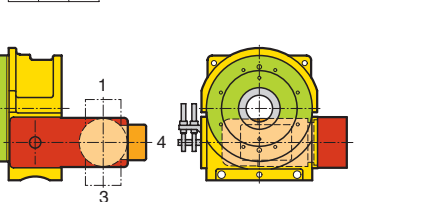

Gearbox drive position 3
Motor mounting position 2

